

## 20A, 500V N-CHANNEL MOSFET

### GENERAL DESCRIPTION

SVF20N50F/PN is an N-channel enhancement mode power MOS field effect transistor which is produced using Silan proprietary F-Cell™ structure VDMOS technology. The improved planar stripe cell and the improved guard ring terminal have been especially tailored to minimize on-state resistance, provide superior switching performance, and withstand high energy pulse in the avalanche and commutation mode.

These devices are widely used in AC-DC power suppliers, DC-DC converters and H-bridge PWM motor drivers.

### FEATURES

- ◆ 20A,500V, $R_{DS(on)(typ.)}=0.20\Omega@V_{GS}=10V$
- ◆ Low gate charge
- ◆ Low Crss
- ◆ Fast switching
- ◆ Improved dv/dt capability

### NOMENCLATURE

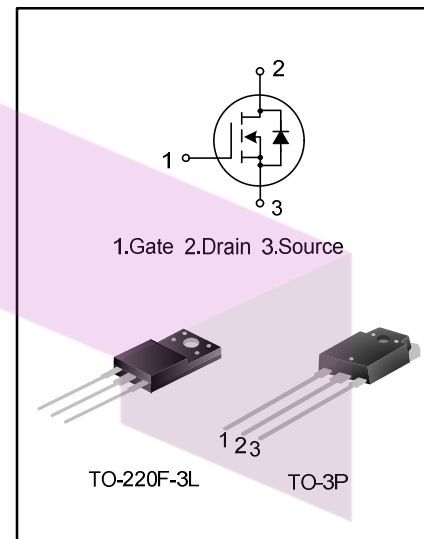
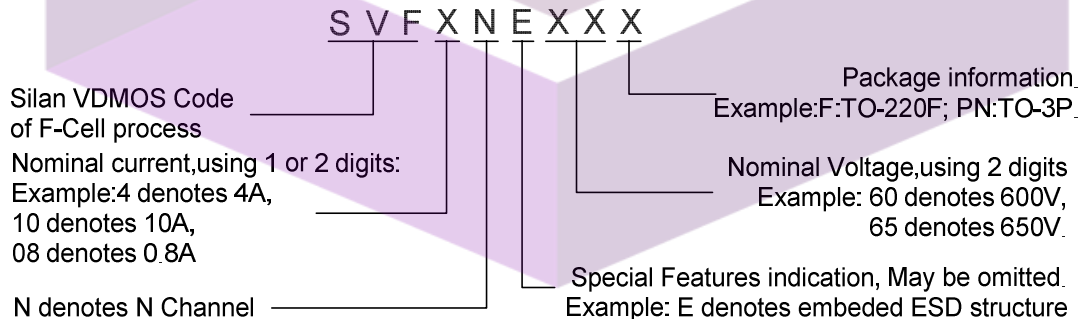

### ORDERING INFORMATION

Part No.	Package	Marking	Material	Packing
SVF20N50F	TO-220F-3L	SVF20N50F	Pb free	Tube
SVF20N50PN	TO-3P	20N50	Pb free	Tube

**ABSOLUTE MAXIMUM RATINGS (T<sub>c</sub>=25°C unless otherwise noted)**

Characteristics	Symbol	Ratings		Unit
		SVF20N50F	SVF20N50PN	
Drain-Source Voltage	V <sub>DS</sub>	500		V
Gate-Source Voltage	V <sub>GS</sub>	±30		V
Drain Current	I <sub>D</sub>	T <sub>C</sub> =25°C		A
		T <sub>C</sub> =100°C		
Drain Current Pulsed	I <sub>DM</sub>	80.0		A
Power Dissipation(T <sub>c</sub> =25°C) -Derate above 25°C	P <sub>D</sub>	72	252	W
		0.58	2.02	W/°C
Single Pulsed Avalanche Energy(Note 1)	E <sub>AS</sub>	1596		mJ
Operation Junction Temperature Range	T <sub>J</sub>	-55~+150		°C
Storage Temperature Range	T <sub>stg</sub>	-55~+150		°C

**THERMAL CHARACTERISTICS**

Characteristics	Symbol	Ratings		Unit
		SVF20N50F	SVF20N50PN	
Thermal Resistance, Junction-to-Case	R <sub>θJC</sub>	1.74	0.50	°C/W
Thermal Resistance, Junction-to-Ambient	R <sub>θJA</sub>	62.5	50	°C/W

**ELECTRICAL CHARACTERISTICS (T<sub>c</sub>=25°C unless otherwise noted)**

Characteristics	Symbol	Test conditions	Min.	Typ.	Max.	Unit
Drain -Source Breakdown Voltage	B <sub>VDS</sub>	V <sub>GS</sub> =0V, I <sub>D</sub> =250μA	500	--	--	V
Drain-Source Leakage Current	I <sub>DSS</sub>	V <sub>DS</sub> =500V, V <sub>GS</sub> =0V	--	--	1.0	μA
Gate-Source Leakage Current	I <sub>GSS</sub>	V <sub>GS</sub> =±30V, V <sub>DS</sub> =0V	--	--	±100	nA
Gate Threshold Voltage	V <sub>GS(th)</sub>	V <sub>GS</sub> = V <sub>DS</sub> , I <sub>D</sub> =250μA	2.0	--	4.0	V
Static Drain- Source On State Resistance	R <sub>DS(on)</sub>	V <sub>GS</sub> =10V, I <sub>D</sub> =10.0A	--	0.20	0.27	Ω
Input Capacitance	C <sub>iss</sub>	V <sub>DS</sub> =25V, V <sub>GS</sub> =0V, f=1.0MHz	--	2687.7	--	pF
Output Capacitance	C <sub>oss</sub>		--	355.0	--	
Reverse Transfer Capacitance	C <sub>rss</sub>		--	10.3	--	
Turn-on Delay Time	t <sub>d(on)</sub>	V <sub>DD</sub> =250V, I <sub>D</sub> =20.0A, R <sub>G</sub> =10Ω, (Note2,3)	--	27.2	--	ns
Turn-on Rise Time	t <sub>r</sub>		--	47.5	--	
Turn-off Delay Time	t <sub>d(off)</sub>		--	78.7	--	
Turn-off Fall Time	t <sub>f</sub>		--	41.1	--	
Total Gate Charge	Q <sub>g</sub>	V <sub>DS</sub> =400V, I <sub>D</sub> =20.0A, V <sub>GS</sub> =10V, (Note 2,3)	--	49.50	--	nC
Gate-Source Charge	Q <sub>gs</sub>		--	14.28	--	
Gate-Drain Charge	Q <sub>gd</sub>		--	16.95	--	

## SOURCE-DRAIN DIODE RATINGS AND CHARACTERISTICS

Characteristics	Symbol	Test conditions	Min.	Typ.	Max.	Unit
Continuous Source Current	$I_S$	Integral Reverse P-N Junction	--	--	20.0	A
Pulsed Source Current	$I_{SM}$	Diode in the MOSFET	--	--	80.0	
Diode Forward Voltage	$V_{SD}$	$I_S=20.0A, V_{GS}=0V$	--	--	1.4	V
Reverse Recovery Time	$T_{rr}$	$I_S=20.0A, V_{GS}=0V,$	--	570.3	--	ns
Reverse Recovery Charge	$Q_{rr}$	$di_F/dt=100A/\mu s$ (Note 2)	--	7.35	--	$\mu C$

### Notes:

1.  $L=30mH, I_{AS}=9.9A, V_{DD}=50V, R_G=25\Omega,$  starting  $T_{BJB}=25^\circ C;$
2. Pulse Test: Pulse width  $\leq 300\mu s,$  Duty cycle  $\leq 2\%;$
3. Essentially independent of operating temperature.

# SKYTECH

تهیه و توزیع قطعات الکترونیک

**TYPICAL CHARACTERISTICS**

Figure 1. On-Region Characteristics

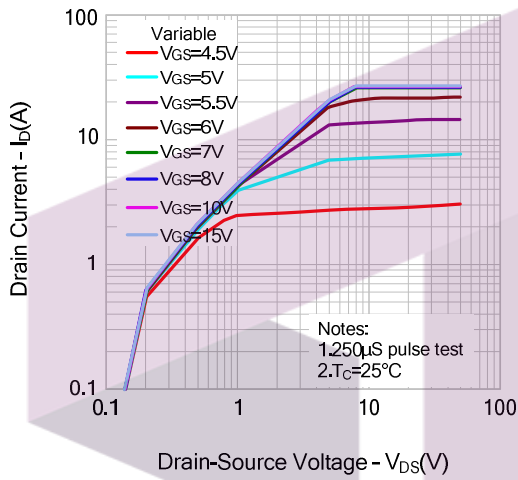

Figure 2. Transfer Characteristics

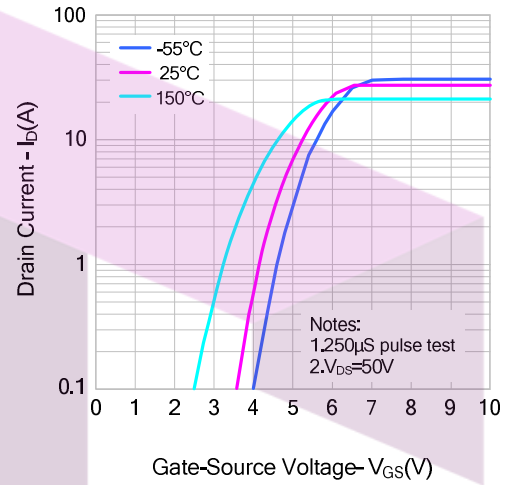

Figure 3. On-Resistance Variation vs. Drain Current and Gate Voltage

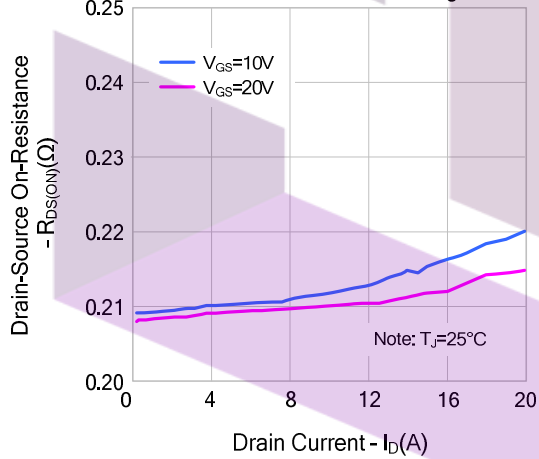

Figure 4. Body Diode Forward Voltage Variation vs. Source Current and Temperature

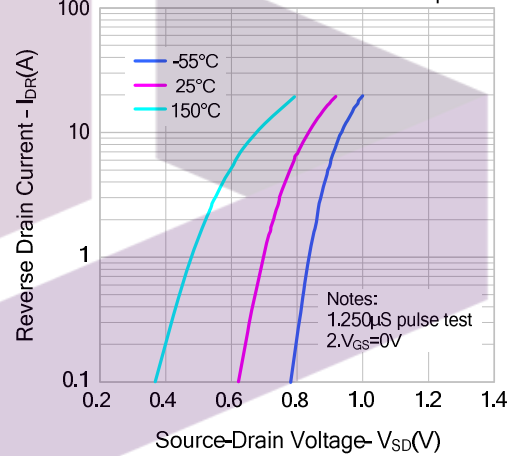

Figure 5. Capacitance Characteristics

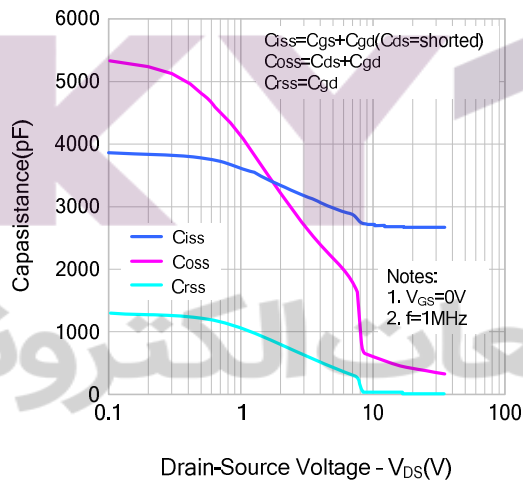
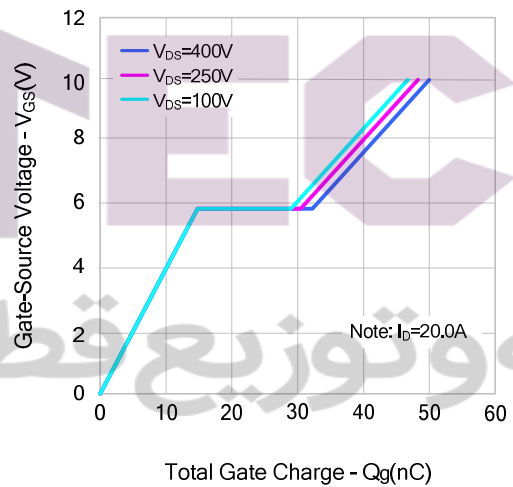
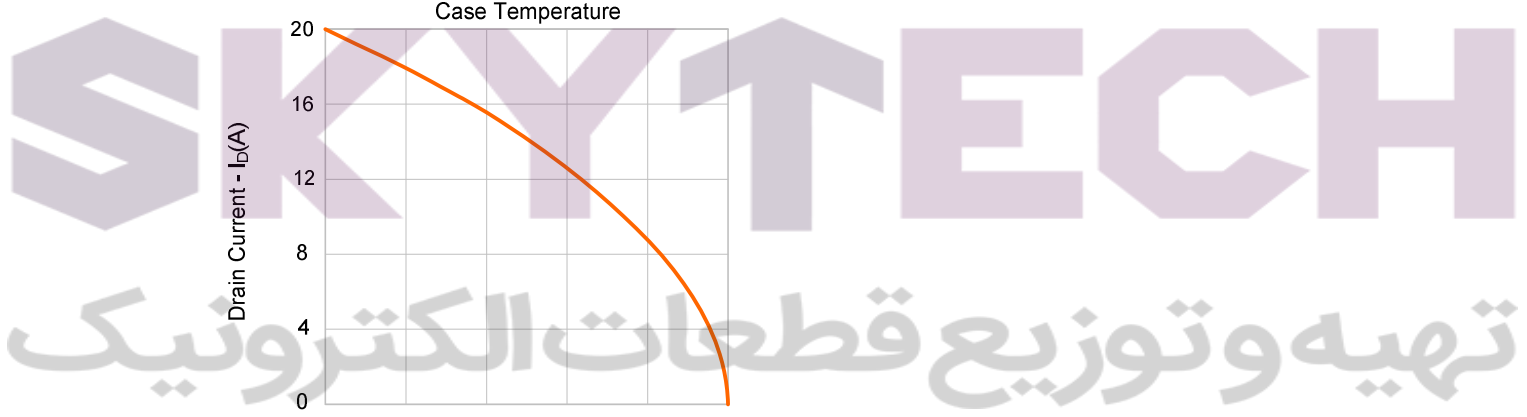
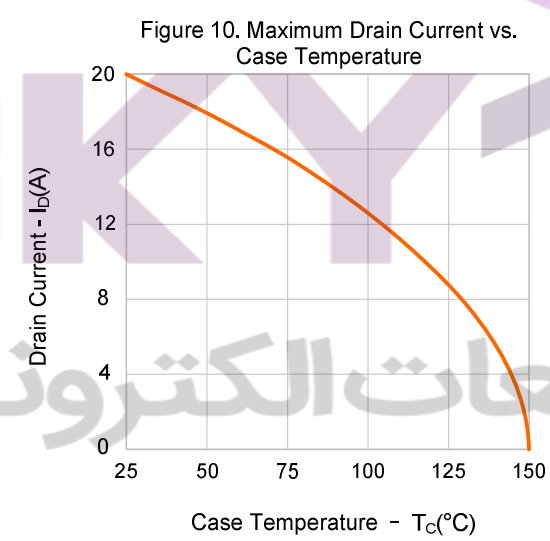
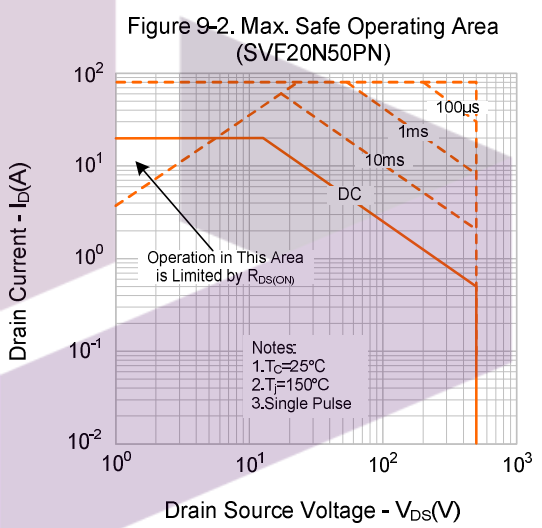
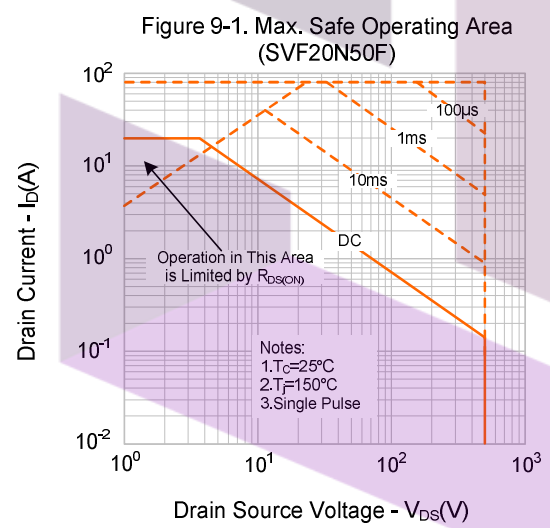
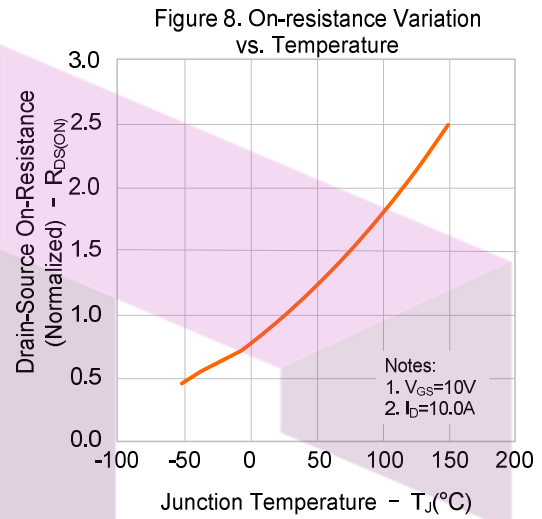
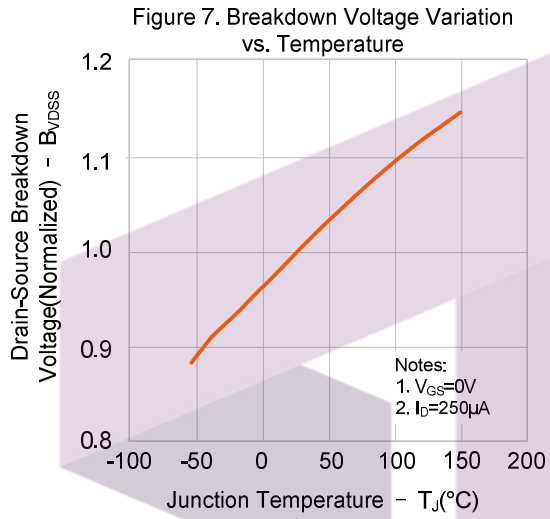

Figure 6. Gate Charge Characteristics



**TYPICAL CHARACTERISTICS(continued)**



**TYPICAL TEST CIRCUIT**

Gate Charge Test Circuit & Waveform

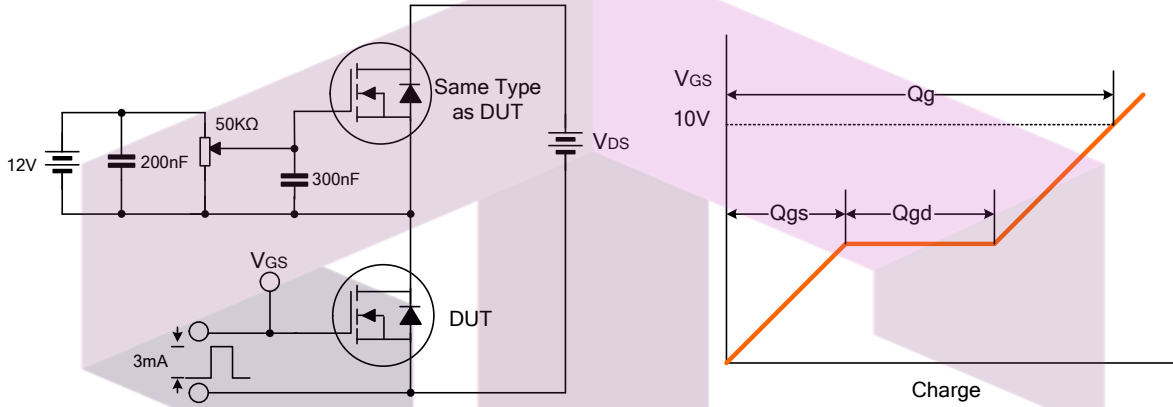

Resistive Switching Test Circuit & Waveform

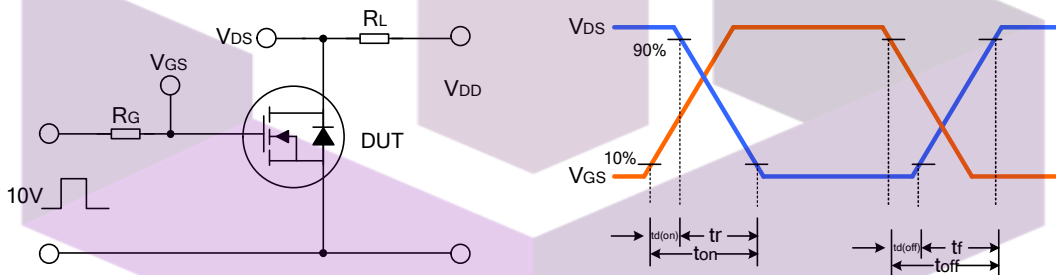

Unclamped Inductive Switching Test Circuit & Waveform

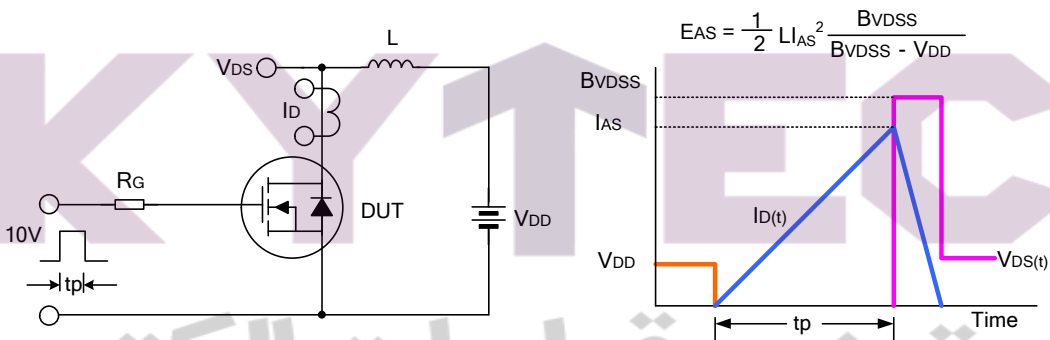

**PACKAGE OUTLINE**

**TO-220F-3L UNIT: mm**

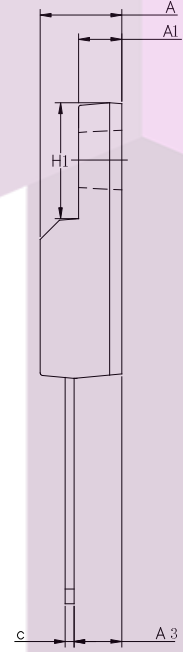
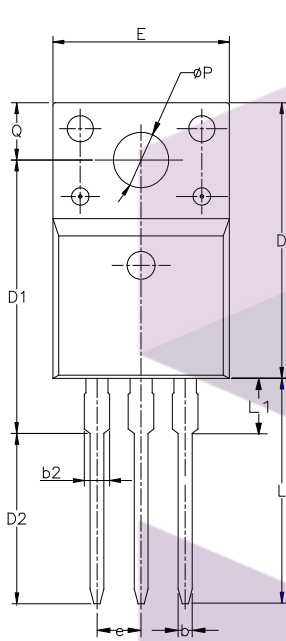

SYMBOL	MIN	NOM	MAX
A	4.42	4.70	5.02
A1	2.30	2.54	2.80
A3	2.50	2.76	3.10
b	0.70	0.80	0.90
b2	—	—	1.47
c	0.35	0.50	0.65
D	15.25	15.87	16.25
D1	15.30	15.75	16.30
D2	9.30	9.80	10.30
E	9.73	10.16	10.36
e	2.54BCS		
H1	6.40	6.68	7.00
L	12.48	12.98	13.48
L1	/	/	3.50
φP	3.00	3.18	3.40
Q	3.05	3.30	3.55

**TO-3P UNIT: mm**

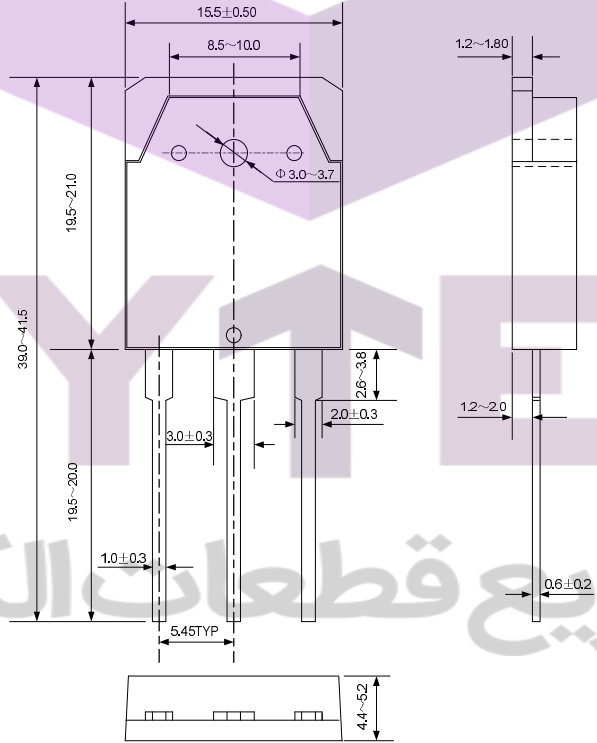

**Disclaimer :**

- Silan reserves the right to make changes to the information herein for the improvement of the design and performance without prior notice! Customers should obtain the latest relevant information before placing orders and should verify that such information is complete and current.
- All semiconductor products malfunction or fail with some probability under special conditions. When using Silan products in system design or complete machine manufacturing, it is the responsibility of the buyer to comply with the safety standards strictly and take essential measures to avoid situations in which a malfunction or failure of such Silan products could cause loss of body injury or damage to property.
- Silan will supply the best possible product for customers!

Part No.:	SVF20N50F/PN	Document Type:	Datasheet
Copyright:	HANGZHOU SILAN MICROELECTRONICS CO.,LTD	Website:	<a href="http://www.silan.com.cn">http://www.silan.com.cn</a>
Rev.:	1.5	Author:	Yin Zi
Revision History:	1. Modify the package information of TO-220F-3L		
Rev.:	1.4	Author:	Yin Zi
Revision History:	1. Modify the thermal characteristics		
Rev.:	1.3	Author:	Yin Zi
Revision History:	1. Modify the ordering information		
Rev.:	1.2	Author:	Zhang Kefeng
Revision History:	1. Change the schematic diagram of MOS		
Rev.:	1.1	Author:	Zhang Kefeng
Revision History:	1. Add the package of TO-3PN 2. Modify "ELECTRICAL CHARACTERISTICS" and "TYPICAL CHARACTERISTICS"		
Rev.:	1.0	Author:	Zhang Kefeng
Revision History:	1. Initial release		

SKYYTECH

تهیه و توزیع قطعات الکترونیک